

**Features**

- Glass Passivated Die Construction
- Super-Fast Recovery Time for High Efficiency
- Low Forward Voltage Drop and High Current Capability
- Patented Interlocking Clip Design for High Surge Current Capacity
- **Lead Free Finish, RoHS Compliant (Note 2)**
- **"Green" Molding Compound (No Br, Sb)**
- **Qualified to AEC-Q101 Standards for High Reliability**

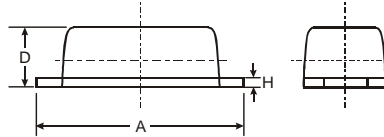

PowerDI®123			
Dim	Min	Max	Typ
A	3.50	3.90	3.70
B	2.60	3.00	2.80
C	1.63	1.93	1.78
D	0.93	1.00	0.98
E	0.85	1.25	1.00
H	0.15	0.25	0.20
L	0.45	0.85	0.65
L1	—	—	1.35
L2	—	—	1.10
L3	—	—	0.20
L4	0.90	1.30	1.05
All Dimensions in mm			

**Mechanical Data**

- Case: PowerDI®123
- Case Material: Molded Plastic, "Green" Molding Compound. UL Flammability Classification Rating 94V-0
- Moisture Sensitivity: Level 1 per J-STD-020C
- Terminal Connections: Cathode Band
- Terminals: Finish – Matte Tin annealed over Copper leadframe. Solderable per MIL-STD-202, Method 208 (E3)
- Marking & Type Code Information: See Page 3
- Ordering Information: See Page 3
- Weight: 0.011 grams (approximate)

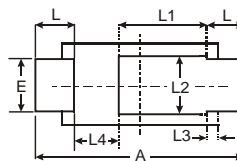
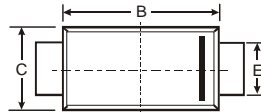

**Maximum Ratings and Electrical Characteristics**

@T<sub>A</sub> = 25°C unless otherwise specified

Single phase, half wave, 60Hz, resistive or inductive load.  
For capacitive load, derate current by 20%.

Characteristic	Symbol	Value	Unit
Peak Repetitive Reverse Voltage	V <sub>RRM</sub>	400	V
Working Peak Reverse Voltage	V <sub>RWM</sub>		
DC Blocking Voltage (Note 5)	V <sub>R</sub>		
RMS Reverse Voltage	V <sub>R(RMS)</sub>	280	V
Average Rectified Output Current	I <sub>O</sub>	1.0	A
Non-Repetitive Peak Forward Surge Current 8.3ms Single Half Sine-Wave Superimposed on Rated Load	I <sub>FSM</sub>	30	A
Maximum Forward Voltage Drop @ I <sub>F</sub> = 1.0A	V <sub>FM</sub>	1.25	V
Peak Reverse Current @ T <sub>A</sub> = 25°C	I <sub>RM</sub>	5.0	μA
at Rated DC Blocking Voltage (Note 5) @ T <sub>A</sub> = 100°C		200	
Maximum Reverse Recovery Time (Note 4)	t <sub>rr</sub>	25	ns
Typical Total Capacitance (f = 1MHz, V <sub>R</sub> = 4VDC)	C <sub>T</sub>	14	pF

**Thermal Characteristics**

Characteristic	Symbol	Typ	Max	Unit
Power Dissipation (Note 1) @ T <sub>A</sub> = 25°C	P <sub>D</sub>	—	1.0	W
Thermal Resistance Junction to Ambient (Note 1) @ T <sub>A</sub> = 25°C	R <sub>θJA</sub>	117	—	°C/W
Thermal Resistance Junction to Soldering Point (Note 3)	R <sub>θJS</sub>	—	6	°C/W
Operating and Storage Temperature Range	T <sub>J</sub> , T <sub>STG</sub>	-65 to +150		°C

- Notes:
1. Device mounted on 1" x 1", Polyimide PCB; 2 oz. Cu pad layout as shown on Diodes Inc. suggested pad layout document AP02001.pdf.
  2. RoHS revision 13.2.2003. Glass and high temperature solder exemptions applied, see EU Directive Annex Notes 5 and 7.
  3. Theoretical R<sub>θJS</sub> calculated from the top center of the die straight down to the PCB cathode tab solder junction.
  4. Measured with I<sub>F</sub> = 0.5A, I<sub>R</sub> = 1.0A, I<sub>r</sub> = 0.25A. See figure 5.
  5. Short duration pulse test used to minimize self-heating effect.
  6. Device mounted on FR-4 PCB, 2oz. Cu pad layout as shown on Diodes Inc. suggested pad layout document AP02001.pdf. (see page 2)

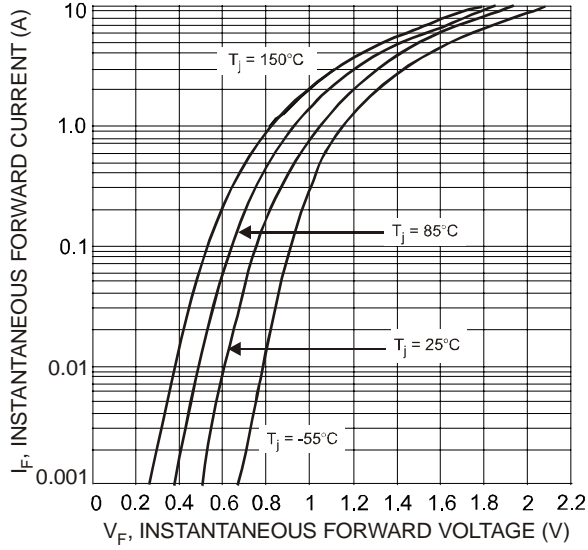

Fig. 1 Typical Forward Characteristics

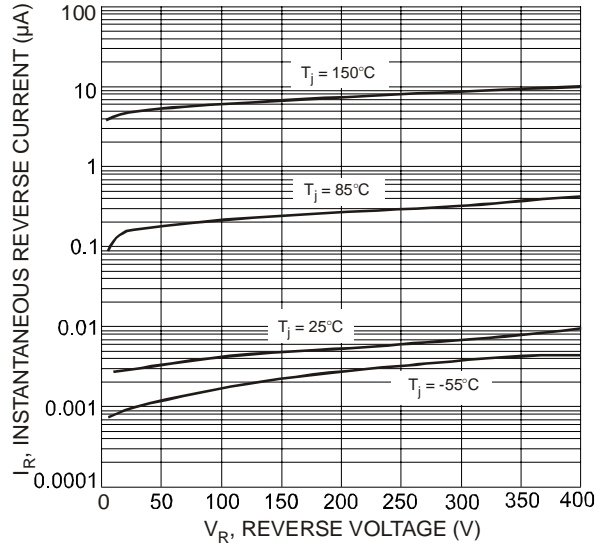

Fig. 2 Typical Reverse Characteristics

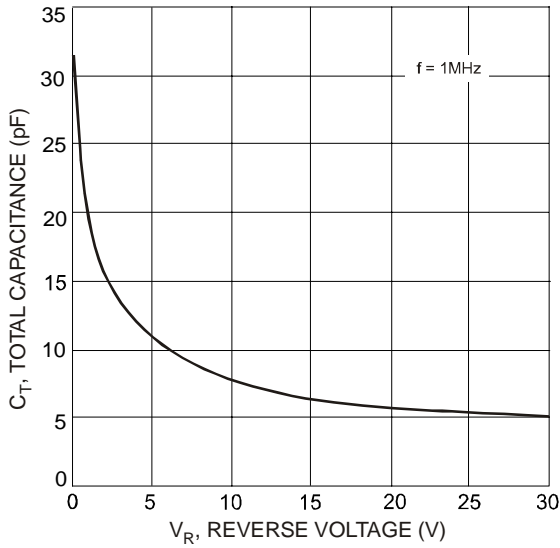

Fig. 3 Typical Total Capacitance

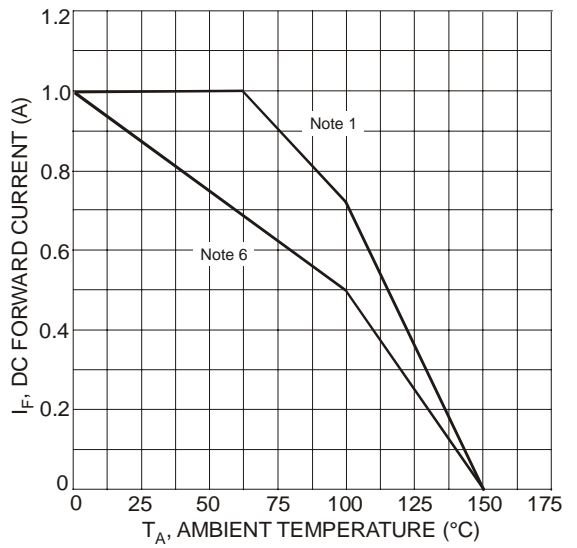

Fig. 4 DC Forward Current Derating

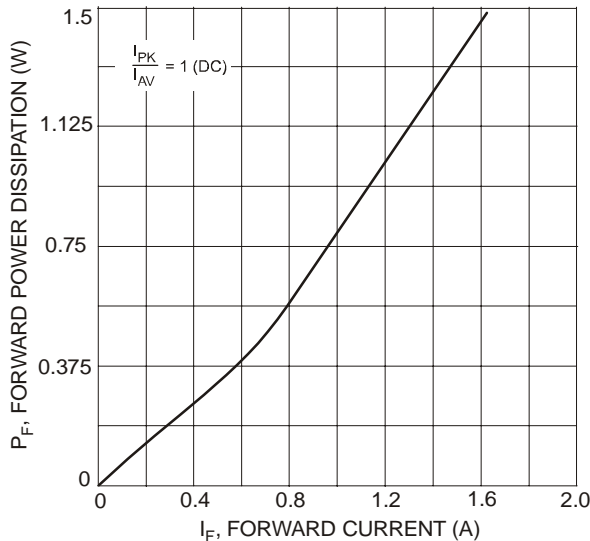

Fig. 5 Forward Power Dissipation

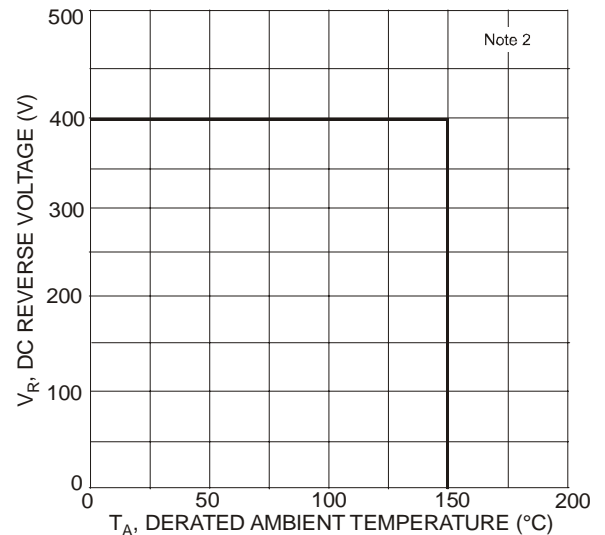
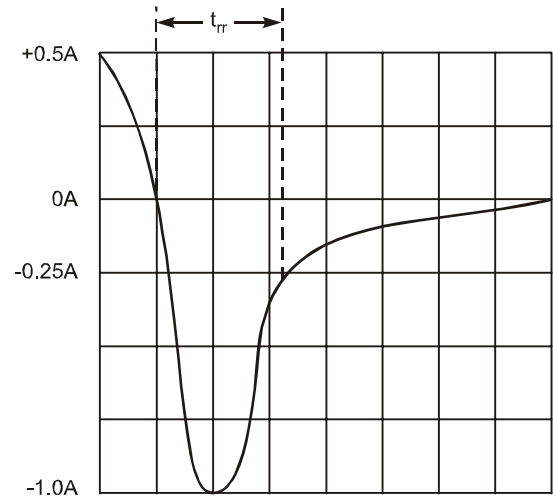
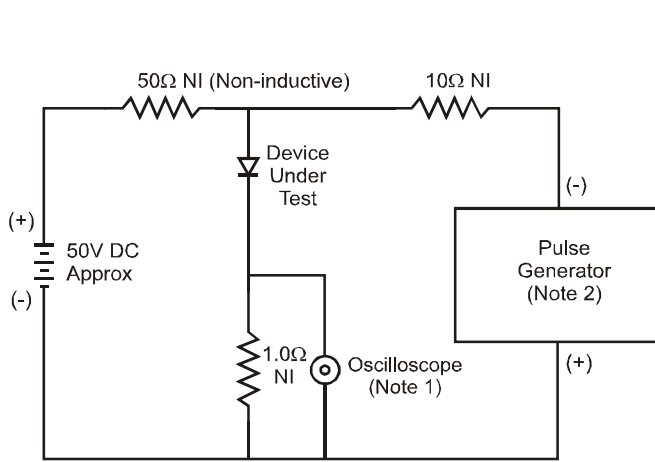

Fig. 6 Operating Temperature Derating



- Notes:
1. Rise Time = 7.0ns max. Input Impedance = 1.0MΩ, 22pF.
  2. Rise Time = 10ns max. Input Impedance = 50Ω.

Set time base for 50/100 ns/cm

Fig. 7 Reverse Recovery Time Characteristic and Test Circuit

## Ordering Information (Note 7)

Device	Packaging	Shipping
DFLU1400-7	PowerDI <sup>®</sup> 123	3000/Tape & Reel

Notes: 7. For packaging details, visit our website at <http://www.diodes.com/datasheets/ap02007.pdf>.

## Marking Information

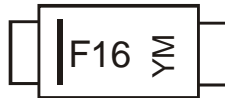

F16 = Product Type Marking Code  
 YM = Date Code Marking  
 Y = Year (ex: T = 2006)  
 M = Month (ex: 9 = September)

### Date Code Key

Year	2005	2006	2007	2008	2009	2010	2011	2012
Code	S	T	U	V	W	X	Y	Z

Month	Jan	Feb	Mar	Apr	May	Jun	Jul	Aug	Sep	Oct	Nov	Dec
Code	1	2	3	4	5	6	7	8	9	O	N	D

### IMPORTANT NOTICE

Diodes Incorporated and its subsidiaries reserve the right to make modifications, enhancements, improvements, corrections or other changes without further notice to any product herein. Diodes Incorporated does not assume any liability arising out of the application or use of any product described herein; neither does it convey any license under its patent rights, nor the rights of others. The user of products in such applications shall assume all risks of such use and will agree to hold Diodes Incorporated and all the companies whose products are represented on our website, harmless against all damages.

### LIFE SUPPORT

Diodes Incorporated products are not authorized for use as critical components in life support devices or systems without the expressed written approval of the President of Diodes Incorporated.